

CTG LNE H760 990x700 RIF. MOD. 18

801809970700

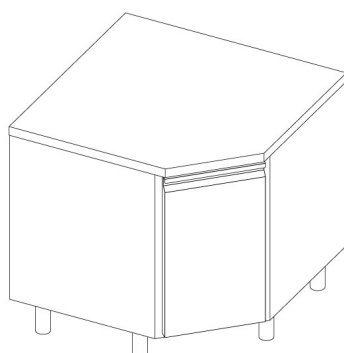

DIMENSIONS AND WEIGHTS

External dimensions in mm. (LxPxH): 990x700x950

Net/gross weight in Kg.:

Through-in door dimensions in mm. (LxP): -

Capacity (Liters): -

Packaging dimensions in mm. (LxPxH): 1370x750x1100

Insulation thickness: /

TECHNICAL FEATURES

Voltage: /

Freon : /

Defrosting: /

Electronic temperature control device: /

Condensation discharge: /

Absorption (W): /

Construction materials: External/internal body made in certified AISI 304 stainless steel

Out put: /

EVAPORATION RESISTANCE: /

DEFROSTING RESISTANCE: /

LIGHTING ABSORPTION: /

Refrigerant charge Kg: /

GENERAL FEATURES

Working temperature: /

Refrigeration system : /

Built-in motor: No

On castors: On demand

Lighting: No

Door with magnetic seal: No

Doors with return: No

ENERGETIC FEATURES

Climate class: /

Refrigeration Volume Vnref (L): /

Freezing Volume Vnfrz (L): /

Typology: /

Daily power consumption E24 h: /

Annual absorption AEC KWh/Annum: /

Performance: /

Category: /

STUDIO 54 SRL

Via Gian Lorenzo Bernini 147 - 35010 San Giorgio in Bosco PD
 T +39 049 9450466 - F +39 0499451044 - Cod. fiscale e p.iva 00096970280 - R.E.A. n. 247856
 www.studio-54.it info@studio-54.it

TECHNICAL DESIGN

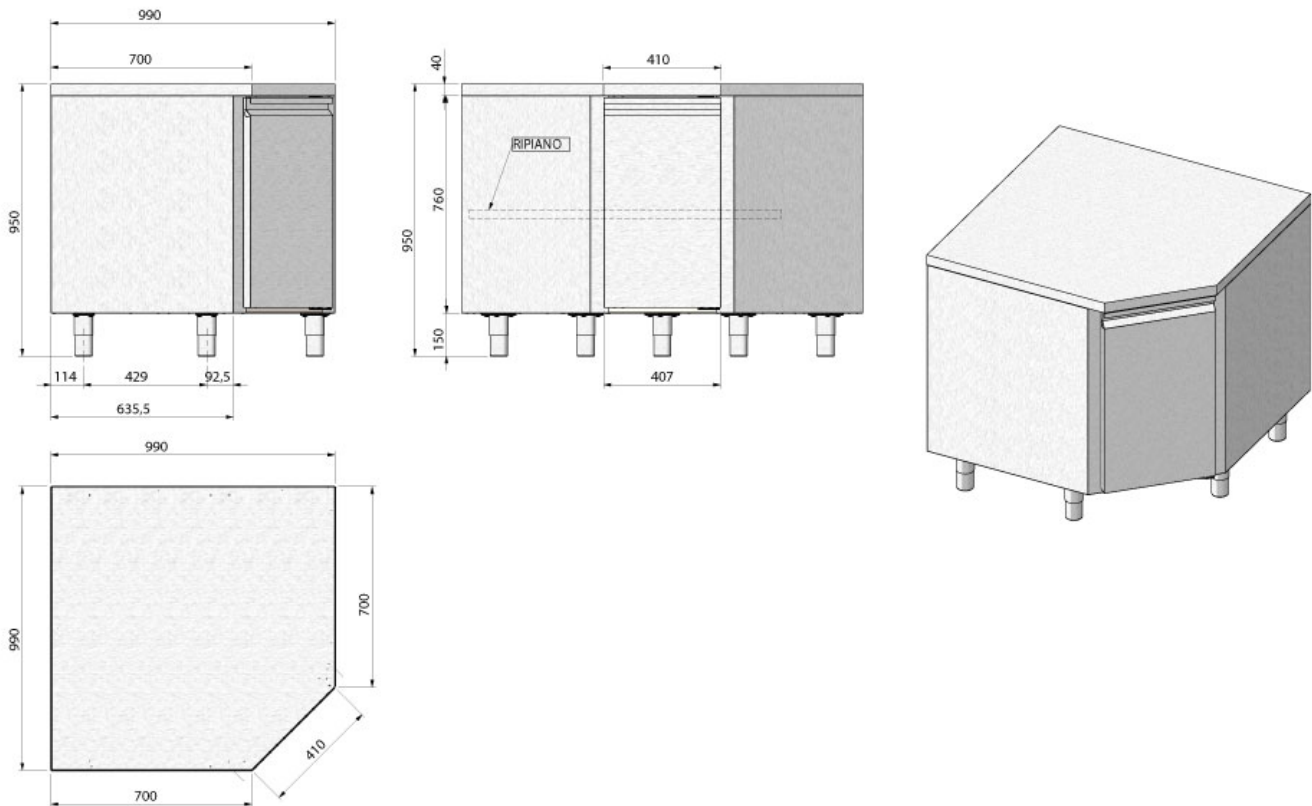

STUDIO-54 S.r.l.
Via Gian Lorenzo Bernini 147, 35010 San Giorgio in Bosco (PD)
T. +39 049 9450466 - F. +39 049 9451044 - C.F. e P.I. 00096970280 - R.E.A. n. 247856
www.studio-54.it info@studio-54.it

OPTIONAL

STUDIO 54 SRL

Via Gian Lorenzo Bernini 147 - 35010 San Giorgio in Bosco PD
T +39 049 9450466 - F +39 0499451044 - Cod. fiscale e p.iva 00096970280 - R.E.A. n. 247856
www.studio-54.it info@studio-54.it