

# CTG LNE H760 1500x700 RIF. MOD. 5

800515070700

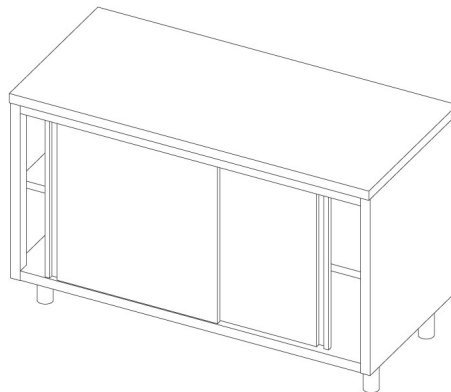

## DIMENSIONS AND WEIGHTS

External dimensions in mm. ( LxPxH ): 1500x700x950
Net/gross weight in Kg.:
Through-in door dimensions in mm. (LxP): -
Capacity ( Liters ): -
Packaging dimensions in mm. (LxPxH): 1800x750x1100
Insulation thickness: /

## TECHNICAL FEATURES

Voltage: /
Freon : /
Defrosting: /
Electronic temperature control device: /
Condensation discharge: /
Absorption ( W ): /
Construction materials: External/internal body made in certified AISI 304 stainless steel
Out put: /
EVAPORATION RESISTANCE: /
DEFROSTING RESISTANCE: /
LIGHTING ABSORPTION: /
Refrigerant charge Kg: /

## GENERAL FEATURES

Working temperature: /
Refrigeration system : /
Built-in motor: No
On castors: On demand
Lighting: No
Door with magnetic seal: No
Doors with return: No

## ENERGETIC FEATURES

Climate class: /
Refrigeration Volume Vnref (L): /
Freezing Volume Vnfrz (L): /
Typology: /
Daily power consumption E24 h: /
Annual absorption AEC KWh/Annum: /
Performance: /
Category: /

## STUDIO 54 SRL

Via Gian Lorenzo Bernini 147 - 35010 San Giorgio in Bosco PD  
 T +39 049 9450466 - F +39 0499451044 - Cod. fiscale e p.iva 00096970280 - R.E.A. n. 247856  
 www.studio-54.it info@studio-54.it

## TECHNICAL DESIGN

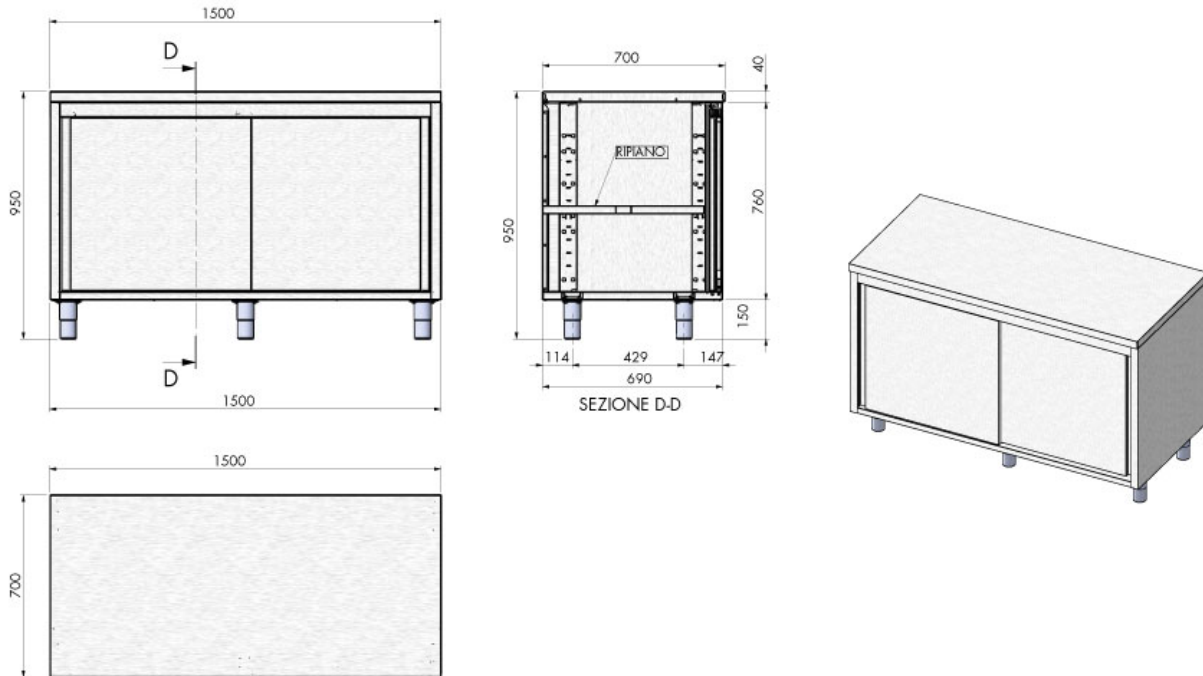

**STUDIO-54 S.r.l.**  
 Via Gian Lorenzo Bernini 147, 35010 San Giorgio in Bosco (PD)  
 T. +39 049 9450466 - F. +39 049 9451044 - C.F e P.I. 00096970280 - R.E.A. n.247856  
[www.studio-54.it](http://www.studio-54.it) [info@studio-54.it](mailto:info@studio-54.it)

## OPTIONAL

### STUDIO 54 SRL

Via Gian Lorenzo Bernini 147 - 35010 San Giorgio in Bosco PD  
 T +39 049 9450466 - F +39 0499451044 - Cod. fiscale e p.iva 00096970280 - R.E.A. n. 247856  
[www.studio-54.it](http://www.studio-54.it) [info@studio-54.it](mailto:info@studio-54.it)