

BAR UR H760 1480x566 +4+10 RIF. MOD. 51

7001020202

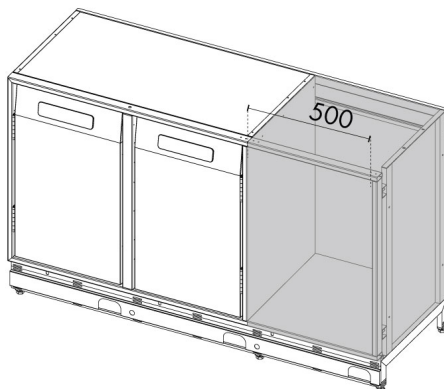

DIMENSIONS AND WEIGHTS

External dimensions in mm. (LxPxH): 1480x566x960

Net/gross weight in Kg.: 97/146

Through-in door dimensions in mm. (LxP): 350x630

Packaging dimensions in mm. (LxPxH): 1580x850x1150

Insulation thickness: 50mm

TECHNICAL FEATURES

Voltage: 230V / 50 Hz / 1PH

Freon : R134a

Defrosting: Automatic

Electronic temperature control device: Yes

Condensation discharge: Ground discharge

Absorption (W): W / /A

Construction materials: AISI 304 stainless steel / support frame in painted / galvanized steel

Out put: 301

EVAPORATION RESISTANCE: /

DEFROSTING RESISTANCE: /

LIGHTING ABSORPTION: /

Refrigerant charge Kg: /

tCO2e: /

GENERAL FEATURES

Working temperature: +4°/+10°C

Refrigeration system : Air forced

Built-in motor: No

On castors: On demand

Lighting: No

Door with magnetic seal: Yes

Doors with return: No

ENERGETIC FEATURES

Climate class: 4 (30°C - 55%)

Refrigeration Volume Vnref (L): /

Freezing Volume Vnfrz (L): /

Typology: /

Daily power consumption E24 h: /

Annual absorption AEC KWh/Annum: /

Performance: /

Category: /

STUDIO 54 SRL

Via Gian Lorenzo Bernini 147 - 35010 San Giorgio in Bosco PD

T +39 049 9450466 - F +39 0499451044 - Cod. fiscale e p.iva 00096970280 - R.E.A. n. 247856

www.studio-54.it info@studio-54.it

TECHNICAL DESIGN

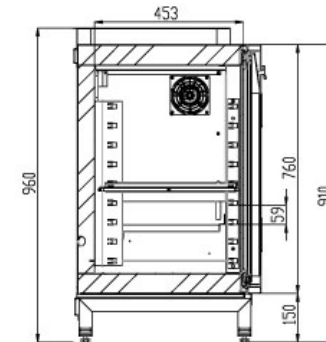
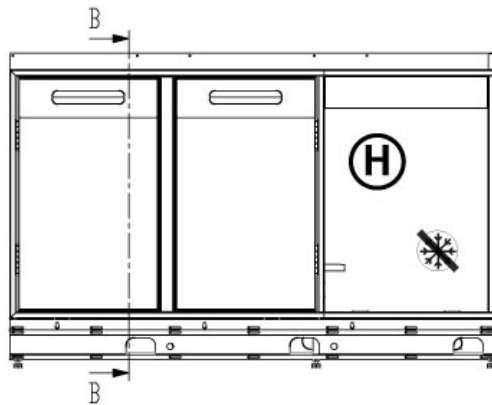

SEZIONE B-B

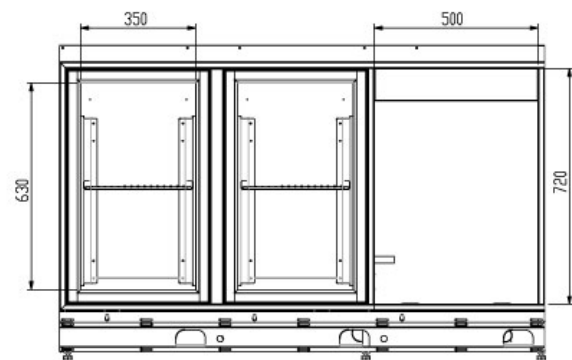
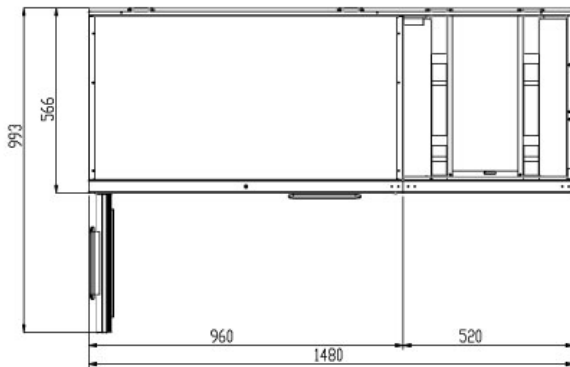

LEGENDA

A: modulo 2 porte battenti - B: modulo porte scorrevoli - C: modulo 1 porta battente - D: cassetto battifondi caffè - E: cassettone - F: cassetiera - H: incasso elettrodomestici - I: tramoggia - L: cassetto sotto drop-in - M: portina

A: 2 hinged-door module - B: sliding door module - C: 1 hing door module - D: coffee waste drawer - E: cassettone - F: drawer - H: electrical appliance recess - I: hopper - L: drop-in drawer - M: door

OPTIONAL

STUDIO 54 SRL

Via Gian Lorenzo Bernini 147 - 35010 San Giorgio in Bosco PD
T +39 049 9450466 - F +39 0499451044 - Cod. fiscale e p.iva 00096970280 - R.E.A. n. 247856
www.studio-54.it info@studio-54.it