

# BAR MT H760 1960x691 +4+10 RIF. MOD. 21

7001010501

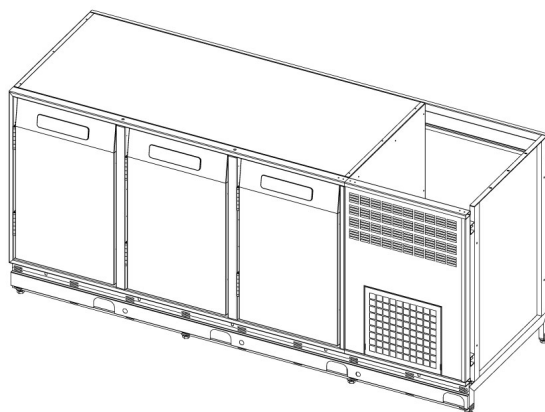

## DIMENSIONS AND WEIGHTS

External dimensions in mm. ( LxPxH ): 1960x691x960

Net/gross weight in Kg.: 156/218

Through-in door dimensions in mm. (LxP): 350x630

Packaging dimensions in mm. (LxPxH): 2060x850x1150

Insulation thickness: 50mm

## TECHNICAL FEATURES

Voltage: 230V / 50 Hz / 1PH

Freon : R134a

Defrosting: Automatic

Electronic temperature control device: Yes

Condensation discharge: Automatic

Absorption ( W ):

Construction materials: AISI 304 stainless steel / support frame in painted / galvanized steel

Out put: 30l

EVAPORATION RESISTANCE: /

DEFROSTING RESISTANCE: /

LIGHTING ABSORPTION: /

Refrigerant charge Kg: 0,3

tCO2e: 1430

## GENERAL FEATURES

Working temperature: +4°/+10°C

Refrigeration system : Air forced

Built-in motor: Yes

On castors: On demand

Lighting: No

Door with magnetic seal: Yes

Doors with return: No

## ENERGETIC FEATURES

Climate class: 4 (30°C - 55%)

Refrigeration Volume Vnref (L): /

Freezing Volume Vnfrz (L): /

Typology: /

Daily power consumption E24 h: /

Annual absorption AEC KWh/Annum: /

Performance: /

Category: /

## STUDIO 54 SRL

Via Gian Lorenzo Bernini 147 - 35010 San Giorgio in Bosco PD  
 T +39 049 9450466 - F +39 0499451044 - Cod. fiscale e p.iva 00096970280 - R.E.A. n. 247856  
 www.studio-54.it info@studio-54.it

# TECHNICAL DESIGN

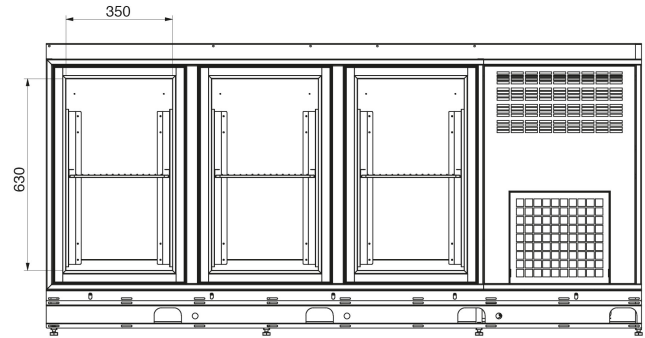
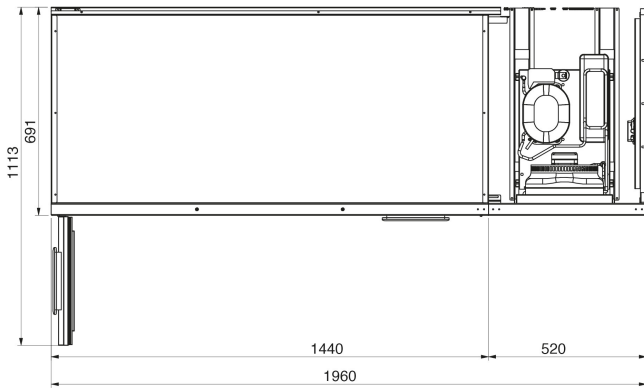
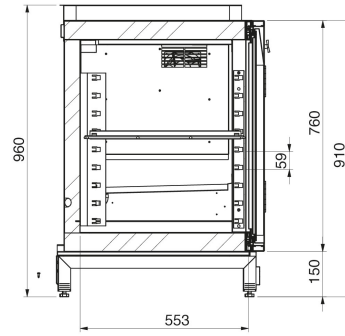
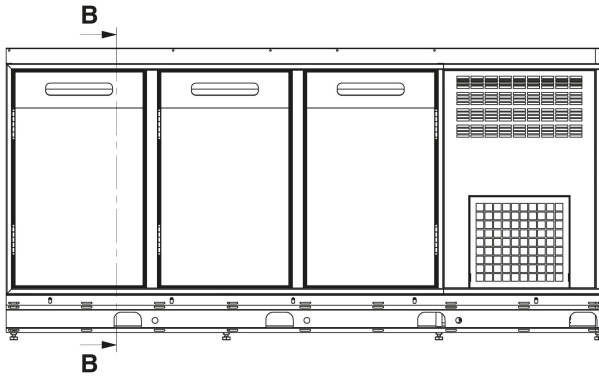

# OPTIONAL

## STUDIO 54 SRL

Via Gian Lorenzo Bernini 147 - 35010 San Giorgio in Bosco PD  
 T +39 049 9450466 - F +39 0499451044 - Cod. fiscale e p.iva 00096970280 - R.E.A. n. 247856  
 www.studio-54.it info@studio-54.it