

# BAR LNE H760 1960x961 RIF. MOD. 9

7001010321

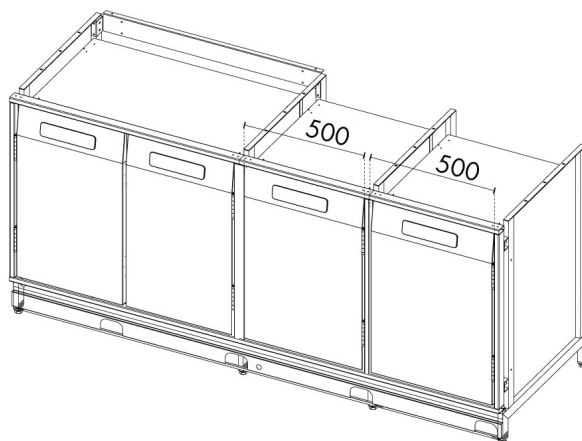

## DIMENSIONS AND WEIGHTS

External dimensions in mm. ( LxPxH ): 1960x691x910

Net/gross weight in Kg.: -

Through-in door dimensions in mm. (LxP): 408x663

Packaging dimensions in mm. (LxPxH): 2060x850x1150

Insulation thickness: /

## TECHNICAL FEATURES

Voltage: /

Freon : /

Defrosting: /

Electronic temperature control device: No

Condensation discharge: /

Absorption ( W ): /

Construction materials: AISI 304 stainless steel / support frame in painted / galvanized steel

Out put: /

EVAPORATION RESISTANCE: /

DEFROSTING RESISTANCE: /

LIGHTING ABSORPTION: /

Refrigerant charge Kg: /

tCO2e: /

## GENERAL FEATURES

Working temperature: /

Refrigeration system : /

Built-in motor: No

On castors: On demand

Lighting: No

Door with magnetic seal: Yes

Doors with return: No

## ENERGETIC FEATURES

Climate class: /

Refrigeration Volume Vnref (L): /

Freezing Volume Vnfrz (L): /

Typology: /

Daily power consumption E24 h: /

Annual absorption AEC KWh/Annum: /

Performance: /

Category: /

## STUDIO 54 SRL

Via Gian Lorenzo Bernini 147 - 35010 San Giorgio in Bosco PD  
 T +39 049 9450466 - F +39 0499451044 - Cod. fiscale e p.iva 00096970280 - R.E.A. n. 247856  
 www.studio-54.it info@studio-54.it

## TECHNICAL DESIGN

## OPTIONAL

### STUDIO 54 SRL

Via Gian Lorenzo Bernini 147 - 35010 San Giorgio in Bosco PD  
T +39 049 9450466 - F +39 0499451044 - Cod. fiscale e p.iva 00096970280 - R.E.A. n. 247856  
[www.studio-54.it](http://www.studio-54.it) [info@studio-54.it](mailto:info@studio-54.it)